

Features:

- Universal AC input range(85~264Vac)
- Support 1+1 or N+1 redundant system (suggest to use redundancy modules.)
- Built-in active PFC,PF>0.95
- High efficiency up to 91%
- Built-in current sharing function
- Built-in current limiting circuit
- Output protections: OVP/OLP/SCP/OTP
- Wide operating ambient temp (-25℃~70℃)
- 150% peak load capacity
- Easy Fuse Tripping due to High Overload Current
- Excellent Partial Load Efficiency
- Built-in DC OK relay contact
- Can be installed on TS-35/7.5 or TS-35/15
- 100% full load burn-in test
- Suitable for critical applications
- Ultra-slim,32mm width
- 3 years warranty



SPECIFICATION

MODEL	DG-75-12	DG-75-24	DG-75-48		
OUTPUT	DC Output	12V	24V	48V	
	Rated Current	6.3A	3.2A	1.6A	
	Current Range	Note 1	0~6.3A	0~3.2A	0~1.6A
	Ripple and Noise	0~70℃	≤100mV	≤120mV	≤120mV
		Note 2	-25℃	≤200mV	≤240mV
	Voltage ADJ. Range	12~14V	24~28V	48~56V	
	Voltage Accuracy	±1.0%			
	Line Regulation	±0.5%			
	Load Regulation	±1.0%			
	Set-up Time	<250mS@230Vac ; <500mS@100Vac			
	Hold up Time	≥20mS(230Vac input, Full load)			
	Temperature Coefficient	±0.03%/℃			
Overshoot and Undershoot	<5.0%				
INPUT	Voltage Range	85Vac~264Vac, 127Vdc-360Vdc			
	Frequency Range	47Hz~63Hz			
	Power Factor (typical)	0.99/100Vac 0.95/230Vac			
	Efficiency (Typical)	88%	91%	91%	
	AC Current (max.)	<0.95 A/100Vac <0.45A/230Vac			
	Inrush Current (Typical)	<30A/100Vac <60A/230Vac Cold start			
	Leakage Current	Input—output:<0.25mA Input—PG:<3.5mA			
PROTECTION	Over Load	110%~150% of rated current, Constant power limiting for some time(150% of rated current, last 3S) then PS stop working for 7S,after 7S,if the load ≤rated current, PS will work normally, auto recovery			
	Over voltage	15~18V	29~33V	58~65V	
		Protection type: Hiccup mode, Auto recovery			
	Over temperature	100±5℃, detect on heat sink of power transistor; shut down O/P, auto recovery after temperature goes down.			
Short Circuit	Long-term mode, auto recovery				
ENVIRONMENT	Operating amb. Temp. & Hum.	-25℃~70℃; 20%~90%RH No condensing			
	Storage Temp. & Hum.	-40℃~85℃; 5%~95%RH No condensing			
SAFETY & EMC Note 3	Safety Standards	meet UL508, UL60950, EN60950			
	Withstand Voltage	Primary-Secondary:3.0KVac; ≤10mA .Primary-PG:2.5KVac; ≤10mA. Secondary-PG:0.5KVac≤10mA.			
	Isolation Resistance	≥100M ohms			
	EMC Emission	Compliance to EN55022, EN55024, FCC PART 15 Class B			
	Harmonic Current	Compliance to EN61000-3-2, CLASS A			
EMC Immunity	Compliance to EN61000-4-2,3,4,5,6,8,11; heavy industry level				
OTHERS	MTBF (MIL-HDBK-217F)	More than 300,000Hrs (25℃, Full load)			

	Dimension (L*W*H)	124*119*32mm
	Packing	28pcs/CTN, 17.6Kg, 0.04cbm
	Cooling method	Cooling by free air convection
Additional function	Power boost	150% of rated current
	DC OK	V On: when output voltage is up to 90% of rated output voltage
		V Off: when output voltage is down to 80% of rated output voltage
	DC OK relay contact rating	Max 30V/1A or 60V/0.3A or 30Vac/0.3A Resistive load
Parallel function	support	
NOTE	<p>1. All parameters NOT specially mentioned are measured at rated input, rated load and 25°C of ambient temperature.</p> <p>2. Measured at 20MHz of bandwidth by using a 12" twisted pair-wire terminated with a 0.1 uF & 10uF parallel capacitor.</p> <p>3. The power supply is considered as a component which will be installed into a final equipment. The final equipment must be re-confirmed that it still meets EMC directives. For guidance on how to perform these EMC tests, please refer to "EMI testing of component power supplies" on http://www.powerld.com.cn.</p>	

Mechanical Specification

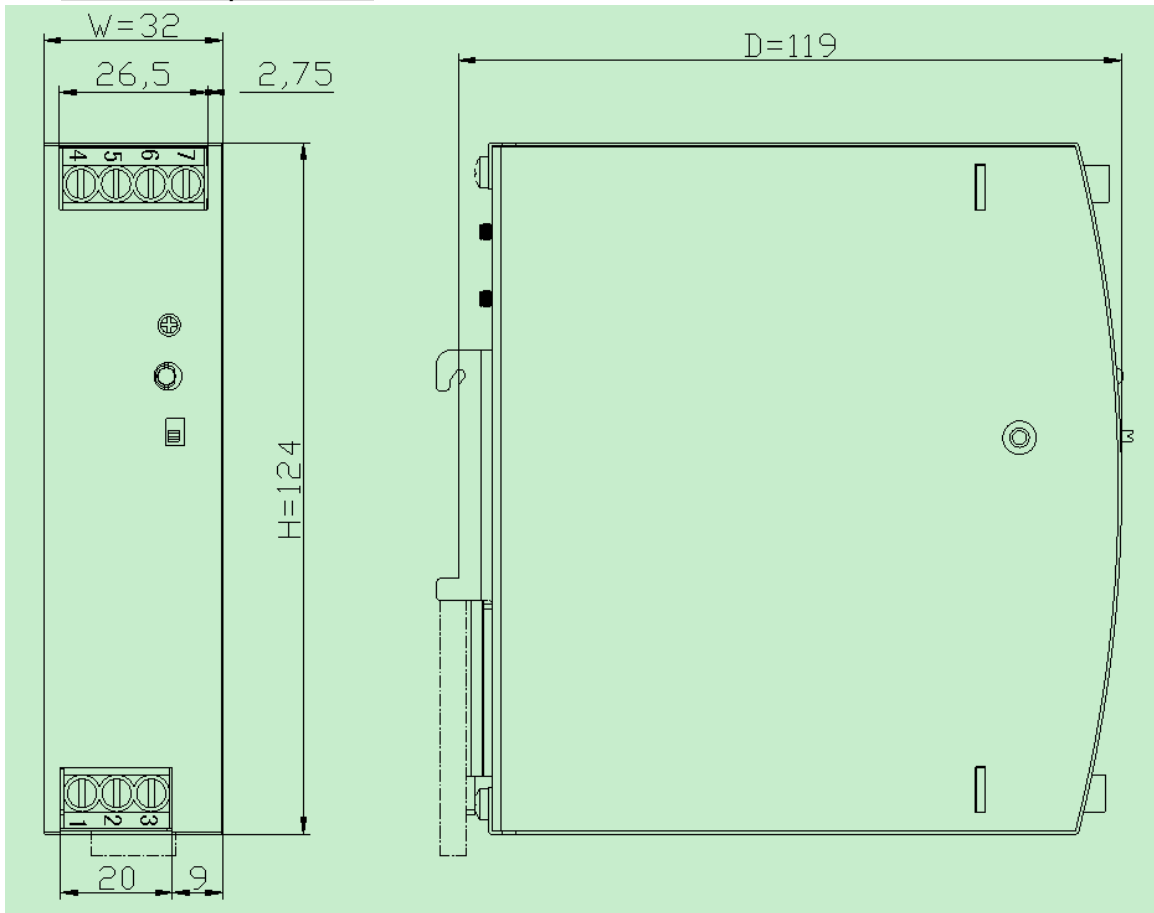
Unit: mm

1.AC terminal blocks installation information

Terminal No.	Function	Wire Spec	Recommended torque
1	L	20~10AWG	1Nm
2	N		
3	PG		

2.DC terminal blocks installation information

Terminal No.	Function	Wire Spec	Recommended torque
4 & 5	DC OK Relay Contact	20~10AWG	1Nm
6	-V		
7	+V		

	AC/DC Terminal
Type	Screw terminal blocks
Solid Wire	0.5-6mm ²
Strand Wire	0.5-4mm ²
Wire Spec	AWG20-10 (PG wire >18AWG)
Max Wire Diameter	2.8mm
Recommended stripping length	7mm
Screwdriver	3.5mm Straight or Cross Screwdriver
Recommended Torque	1NM

■ **Block Diagram**

Fig. 11-1 **Functional diagram**

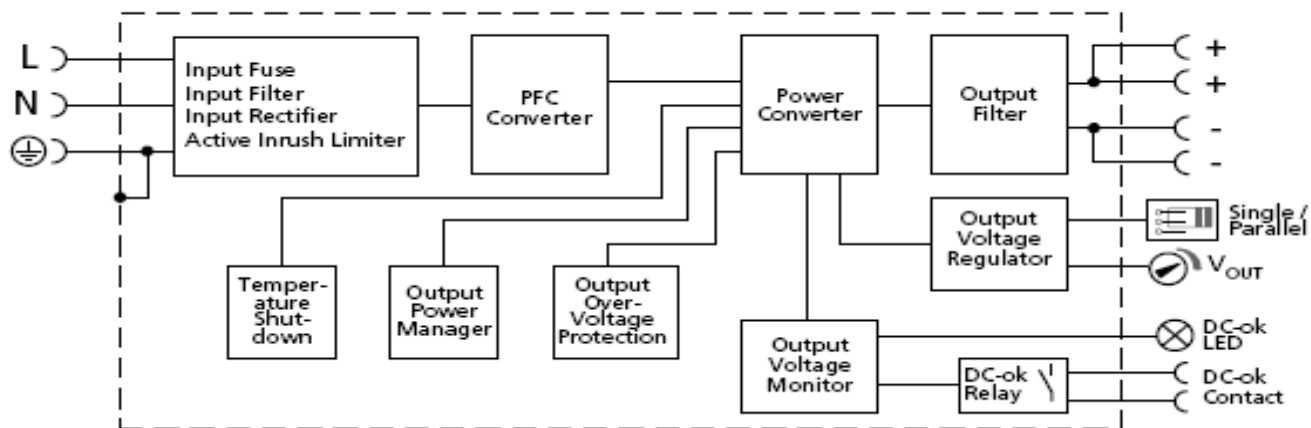

■ **Derating Curve**

DG-75-12

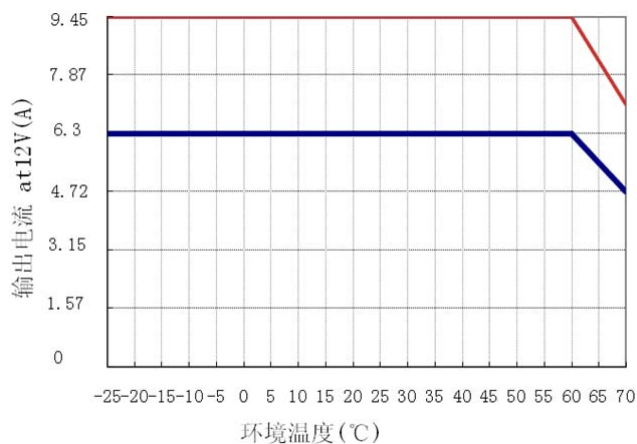

DG-75-24

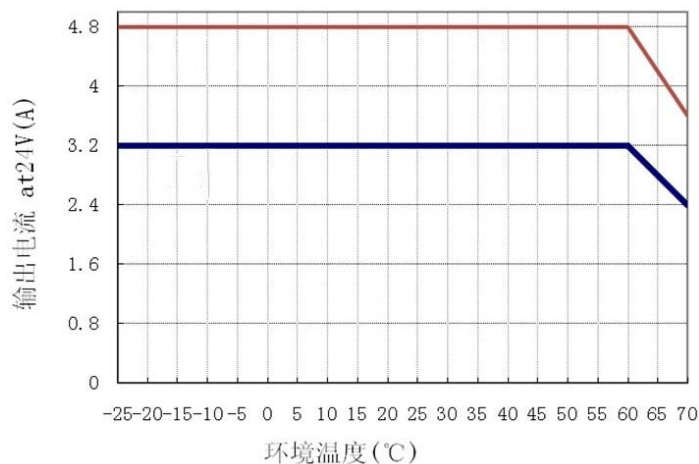

DG-75-48

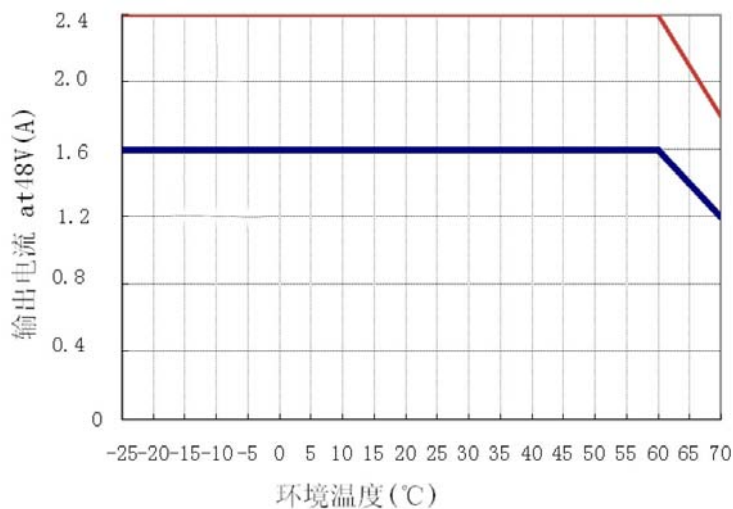

: short time working;
 : continual working.

■ **Mounting method instruction**

A1 is recommended output current

A2 is the allowed max output current (PSU lifetime is around half of A1)

DG-75-12

Mounting A

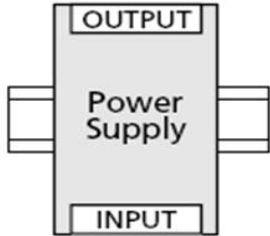

Output Current

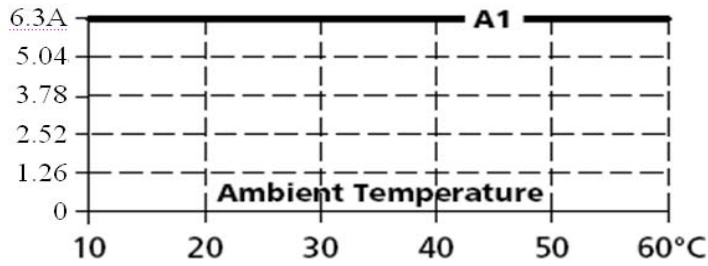

Mounting B

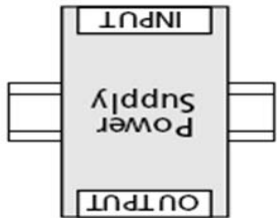

Output Current

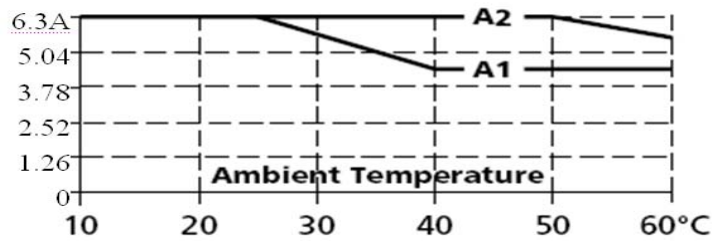

Mounting C

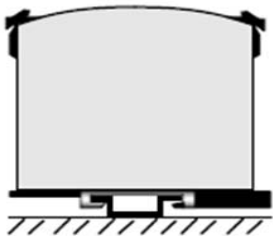

Output Current

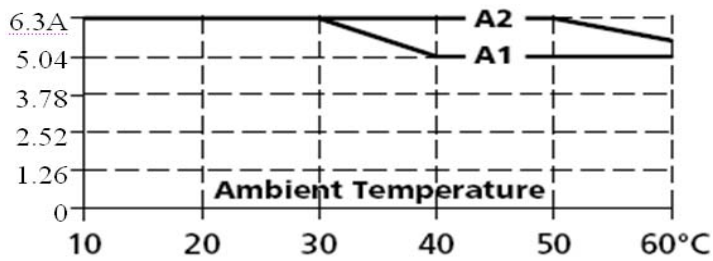

Mounting D

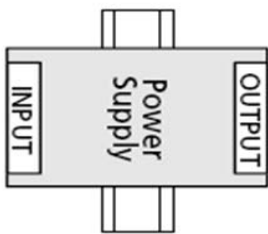

Output Current

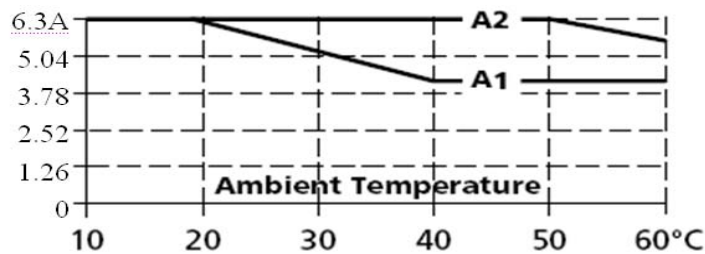

Mounting E

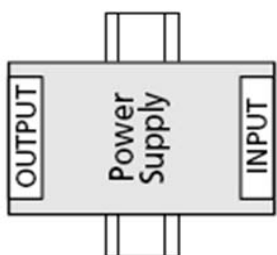

Output Current

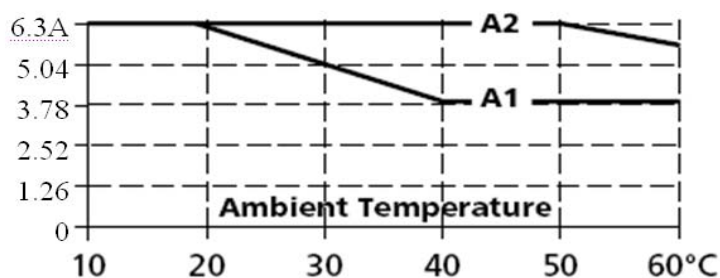

DG-75-24

Mounting A

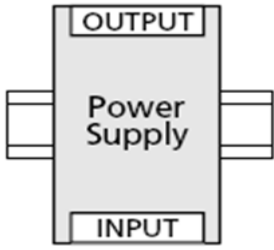

Output Current

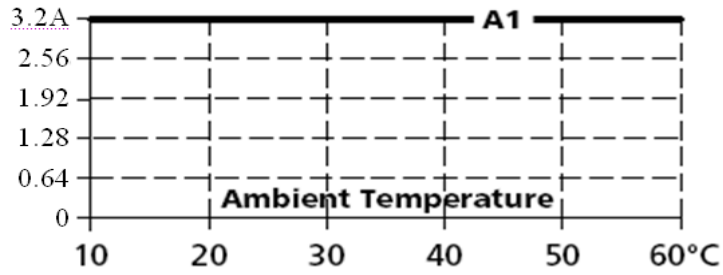

Mounting B

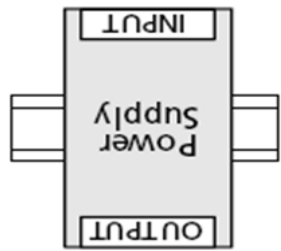

Output Current

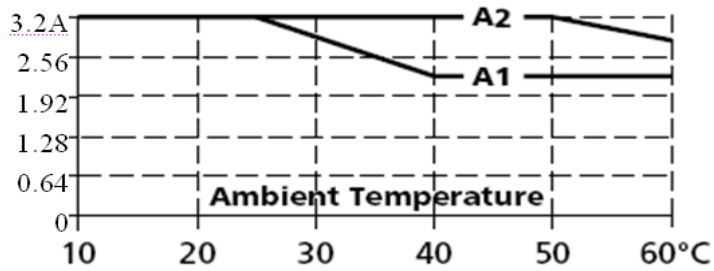

Mounting C

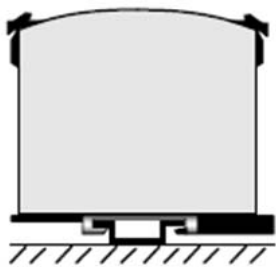

Output Current

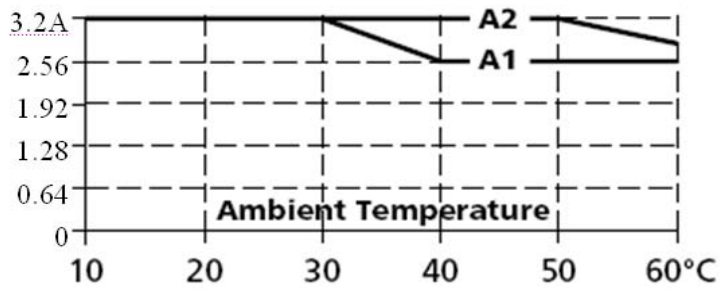

Mounting D

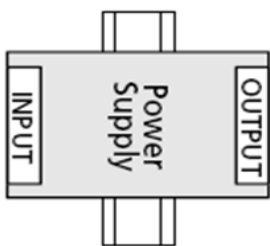

Output Current

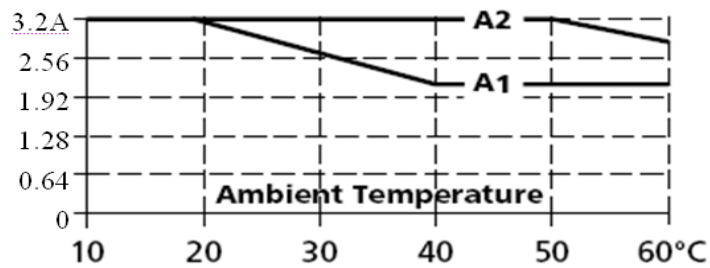

Mounting E

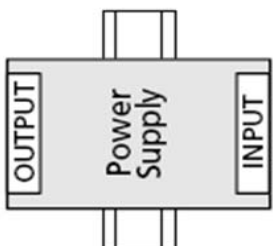

Output Current

